



# STB60NE06L-16

N-CHANNEL 60V - 0.014  $\Omega$  - 60A D<sup>2</sup>PAK

STripFET™ II POWER MOSFET

TYPE	V <sub>DSS</sub>	R <sub>DS(on)</sub>	I <sub>D</sub>
STB60NE06L-16	60 V	<0.016 $\Omega$	60 A

- TYPICAL R<sub>DS(on)</sub> = 0.014  $\Omega$
- AVALANCHE RUGGED TECHNOLOGY
- LOW GATE CHARGE
- HIGH CURRENT CAPABILITY
- 175 °C OPERATING TEMPERATURE
- LOW THRESHOLD DRIVE
- SURFACE-MOUNTING D<sup>2</sup>PAK (TO-263) POWER PACKAGE IN TUBE (NO SUFFIX) OR IN TAPE & REEL (SUFFIX "T4")

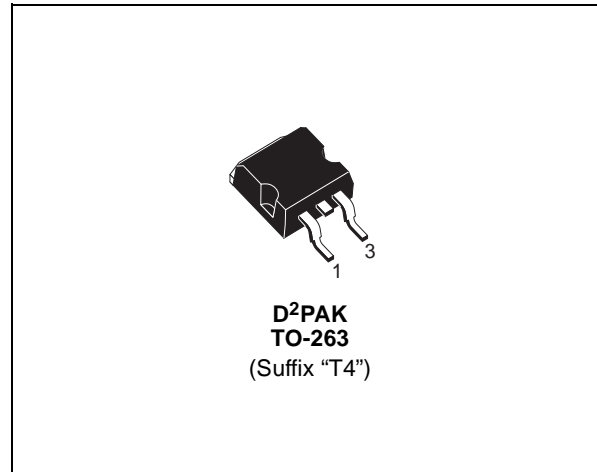

## DESCRIPTION

This Power MOSFET is the latest development of STMicroelectronics unique "Single Feature Size™" strip-based process. The resulting transistor shows extremely high packing density for low on-resistance, rugged avalanche characteristics and less critical alignment steps therefore a remarkable manufacturing reproducibility.

## APPLICATIONS

- HIGH CURRENT, HIGH SWITCHING SPEED
- SOLENOID AND RELAY DRIVERS
- DC-DC & DC-AC CONVERTERS
- AUTOMOTIVE ENVIRONMENT

## ABSOLUTE MAXIMUM RATINGS

Symbol	Parameter	Value	Unit
V <sub>DS</sub>	Drain-source Voltage (V <sub>GS</sub> = 0)	60	V
V <sub>DGR</sub>	Drain-gate Voltage (R <sub>GS</sub> = 20 k $\Omega$ )	60	V
V <sub>GS</sub>	Gate- source Voltage	$\pm 15$	V
I <sub>D</sub>	Drain Current (continuous) at T <sub>C</sub> = 25°C	60	A
I <sub>D</sub>	Drain Current (continuous) at T <sub>C</sub> = 100°C	42	A
I <sub>DM</sub> (•)	Drain Current (pulsed)	240	A
P <sub>tot</sub>	Total Dissipation at T <sub>C</sub> = 25°C	150	W
	Derating Factor	1	W/°C
dv/dt (1)	Peak Diode Recovery voltage slope	11	V/ns
E <sub>AS</sub> (2)	Single Pulse Avalanche Energy	400	mJ
T <sub>stg</sub>	Storage Temperature	-55 to 175	°C
T <sub>j</sub>	Operating Junction Temperature		

(•) Pulse width limited by safe operating area.

## INTERNAL SCHEMATIC DIAGRAM

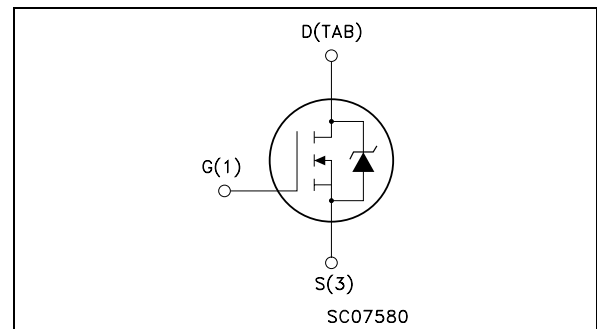

(1) I<sub>SD</sub>  $\leq$  60A, di/dt  $\leq$  300A/ $\mu$ s, V<sub>DD</sub>  $\leq$  V<sub>(BR)DSS</sub>, T<sub>j</sub>  $\leq$  T<sub>JMAX</sub>

(2) Starting T<sub>j</sub> = 25 °C, I<sub>D</sub> = 60A, V<sub>DD</sub> = 35V

**STB60NE06L-16****THERMAL DATA**

Rthj-case	Thermal Resistance Junction-case	Max	1	°C/W
Rthj-amb	Thermal Resistance Junction-ambient	Max	62.5	°C/W
T <sub>l</sub>	Maximum Lead Temperature For Soldering Purpose		300	°C

**ELECTRICAL CHARACTERISTICS** (T<sub>case</sub> = 25 °C unless otherwise specified)

OFF

Symbol	Parameter	Test Conditions	Min.	Typ.	Max.	Unit
V <sub>(BR)DSS</sub>	Drain-source Breakdown Voltage	I <sub>D</sub> = 250 μA, V <sub>GS</sub> = 0	60			V
I <sub>DSS</sub>	Zero Gate Voltage Drain Current (V <sub>GS</sub> = 0)	V <sub>DS</sub> = Max Rating V <sub>DS</sub> = Max Rating T <sub>C</sub> = 125°C			1 10	μA μA
I <sub>GSS</sub>	Gate-body Leakage Current (V <sub>DS</sub> = 0)	V <sub>GS</sub> = ± 15V			±100	nA

ON (\*)

Symbol	Parameter	Test Conditions	Min.	Typ.	Max.	Unit
V <sub>GS(th)</sub>	Gate Threshold Voltage	V <sub>DS</sub> = V <sub>GS</sub> I <sub>D</sub> = 250 μA	1	1.6	2.5	V
R <sub>DS(on)</sub>	Static Drain-source On Resistance	V <sub>GS</sub> = 5 V I <sub>D</sub> = 30 A V <sub>GS</sub> = 10 V I <sub>D</sub> = 30 A		0.014 0.012	0.016 0.014	Ω Ω

DYNAMIC

Symbol	Parameter	Test Conditions	Min.	Typ.	Max.	Unit
g <sub>fs</sub> (*)	Forward Transconductance	V <sub>DS</sub> > I <sub>D(on)</sub> × R <sub>DS(on)max</sub> I <sub>D</sub> = 30 A		30		S
C <sub>iss</sub>	Input Capacitance	V <sub>DS</sub> = 25V f = 1 MHz V <sub>GS</sub> = 0		4150		pF
C <sub>oss</sub>	Output Capacitance			590		pF
C <sub>rss</sub>	Reverse Transfer Capacitance			150		pF

**ELECTRICAL CHARACTERISTICS** (continued)

**SWITCHING ON**

Symbol	Parameter	Test Conditions	Min.	Typ.	Max.	Unit
$t_{d(on)}$ $t_r$	Turn-on Time Rise Time	$V_{DD} = 30\text{ V}$ $I_D = 30\text{ A}$ $R_G = 4.7\ \Omega$ $V_{GS} = 4.5\text{ V}$ (Resistive Load, Figure 3)		50 155		ns ns
$Q_g$ $Q_{gs}$ $Q_{gd}$	Total Gate Charge Gate-Source Charge Gate-Drain Charge	$V_{DD} = 40\text{ V}$ $I_D = 60\text{ A}$ $V_{GS} = 5\text{ V}$		55 15 30	70	nC nC nC

**SWITCHING OFF**

Symbol	Parameter	Test Conditions	Min.	Typ.	Max.	Unit
$t_r(V_{off})$ $t_f$ $t_c$	Off-Voltage Rise Time Fall Time Cross-over Time	$V_{clamp} = 48\text{ V}$ $I_D = 20\text{ A}$ $R_G = 4.7\ \Omega$ $V_{GS} = 5\text{ V}$ (Inductive Load, Figure 5)		45 220 280		ns ns ns

**SOURCE DRAIN DIODE**

Symbol	Parameter	Test Conditions	Min.	Typ.	Max.	Unit
$I_{SD}$ $I_{SDM}^{(*)}$	Source-drain Current Source-drain Current (pulsed)				60 240	A A
$V_{SD}^{(*)}$	Forward On Voltage	$I_{SD} = 60\text{ A}$ $V_{GS} = 0$			1.3	V
$t_{rr}$ $Q_{rr}$ $I_{RRM}$	Reverse Recovery Time Reverse Recovery Charge Reverse Recovery Current	$I_{SD} = 60\text{ A}$ $di/dt = 100\text{ A}/\mu\text{s}$ $V_{DD} = 30\text{ V}$ $T_j = 150^\circ\text{C}$ (see test circuit, Figure 5)		85 300 7		ns nC A

(\*) Pulsed: Pulse duration = 300  $\mu\text{s}$ , duty cycle 1.5 %.  
 (●) Pulse width limited by safe operating area.

Safe Operating Area

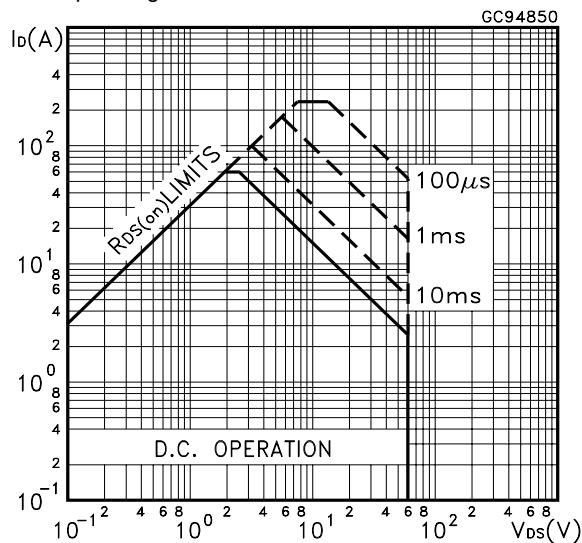

Thermal Impedance

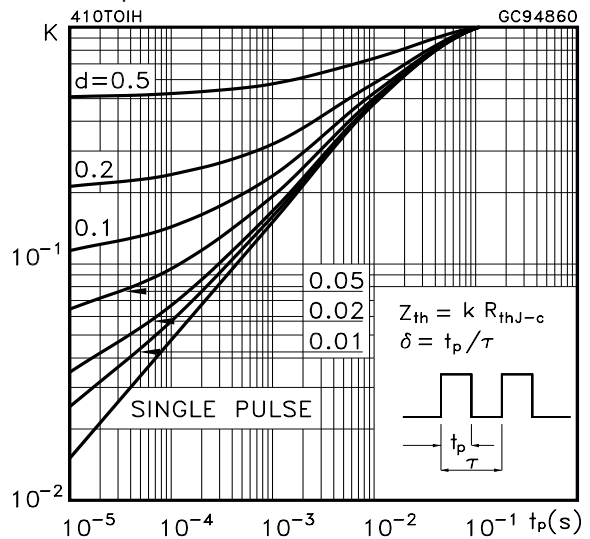

Output Characteristics

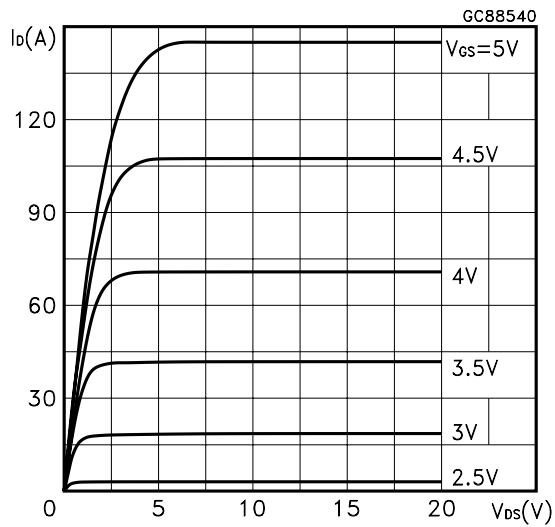

Transfer Characteristics

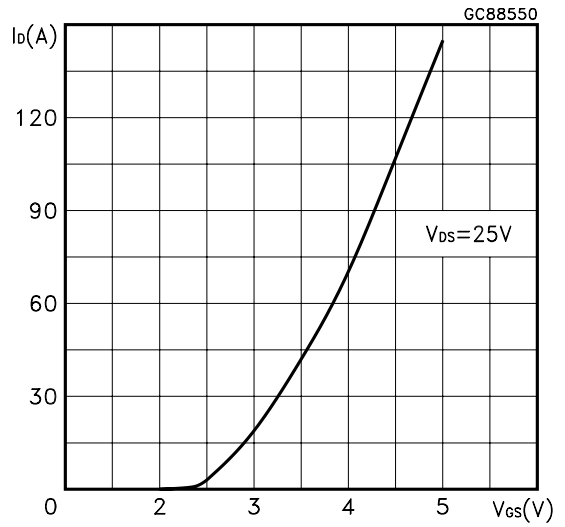

Transconductance

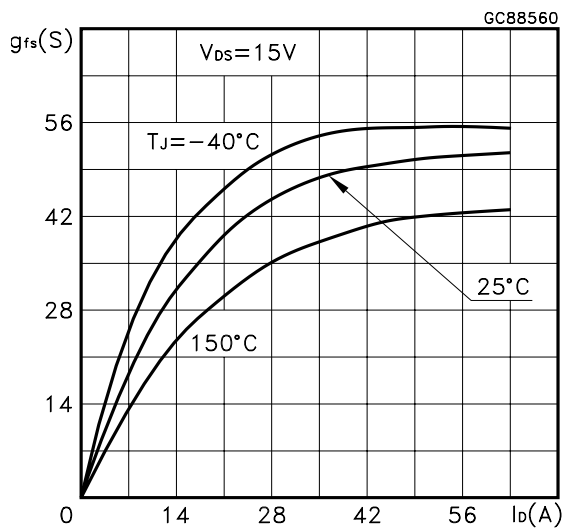

Static Drain-source On Resistance

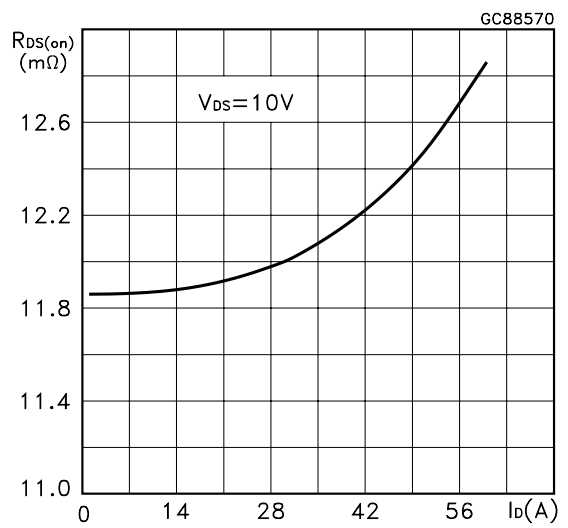

Gate Charge vs Gate-source Voltage

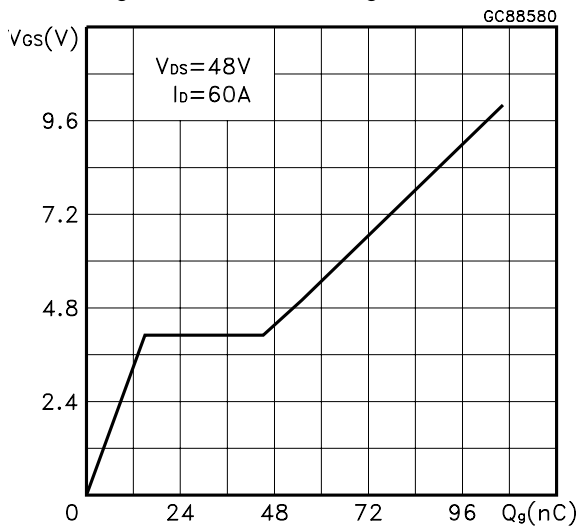

Capacitance Variations

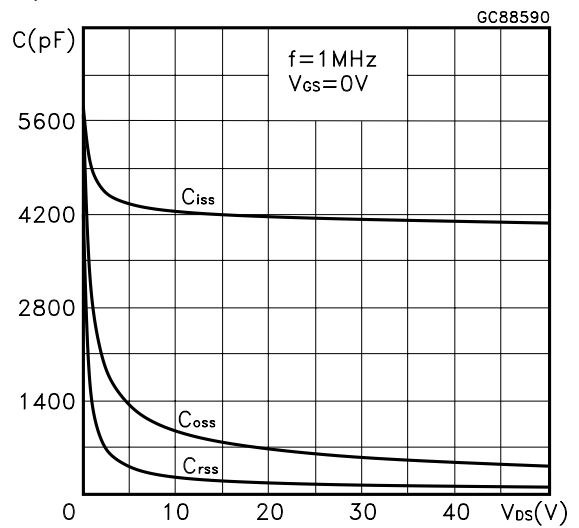

Normalized Gate Threshold Voltage vs Temperature

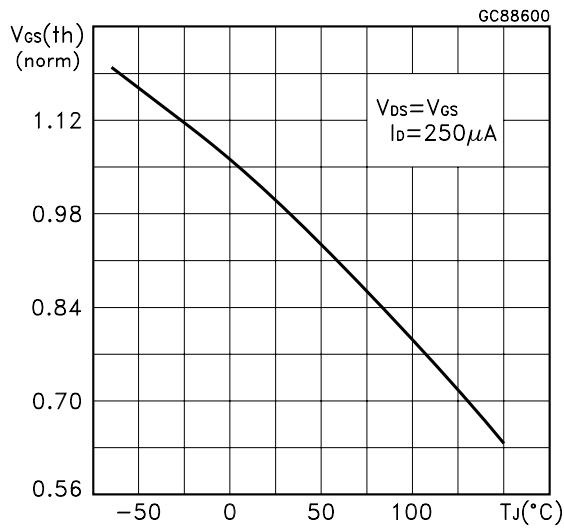

Normalized on Resistance vs Temperature

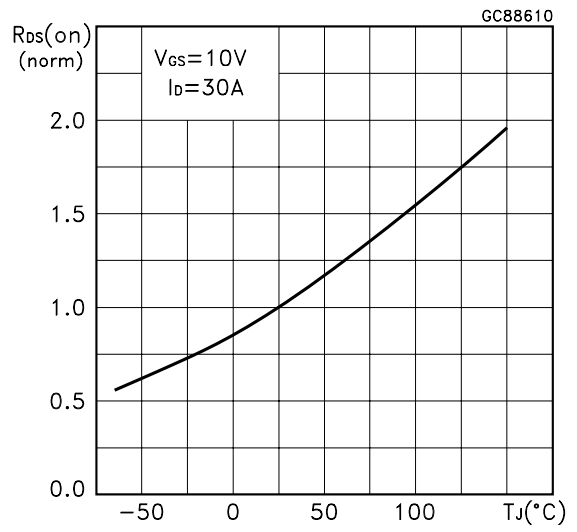

Source-drain Diode Forward Characteristics

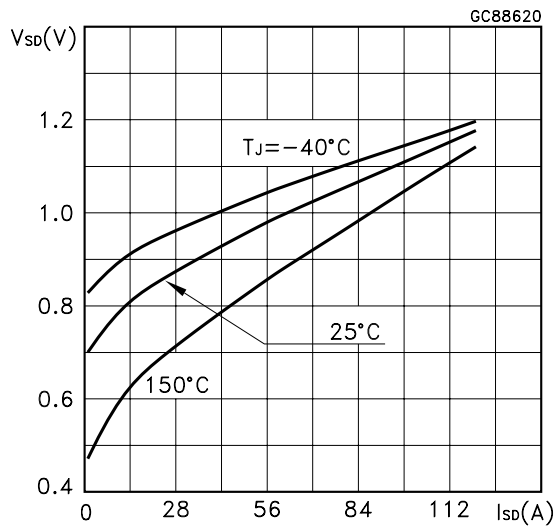

Normalized Breakdown Voltage Temperature

**Fig. 1: Unclamped Inductive Load Test Circuit**



**Fig. 2: Unclamped Inductive Waveform**



**Fig. 3: Switching Times Test Circuits For Resistive Load**



**Fig. 4: Gate Charge test Circuit**

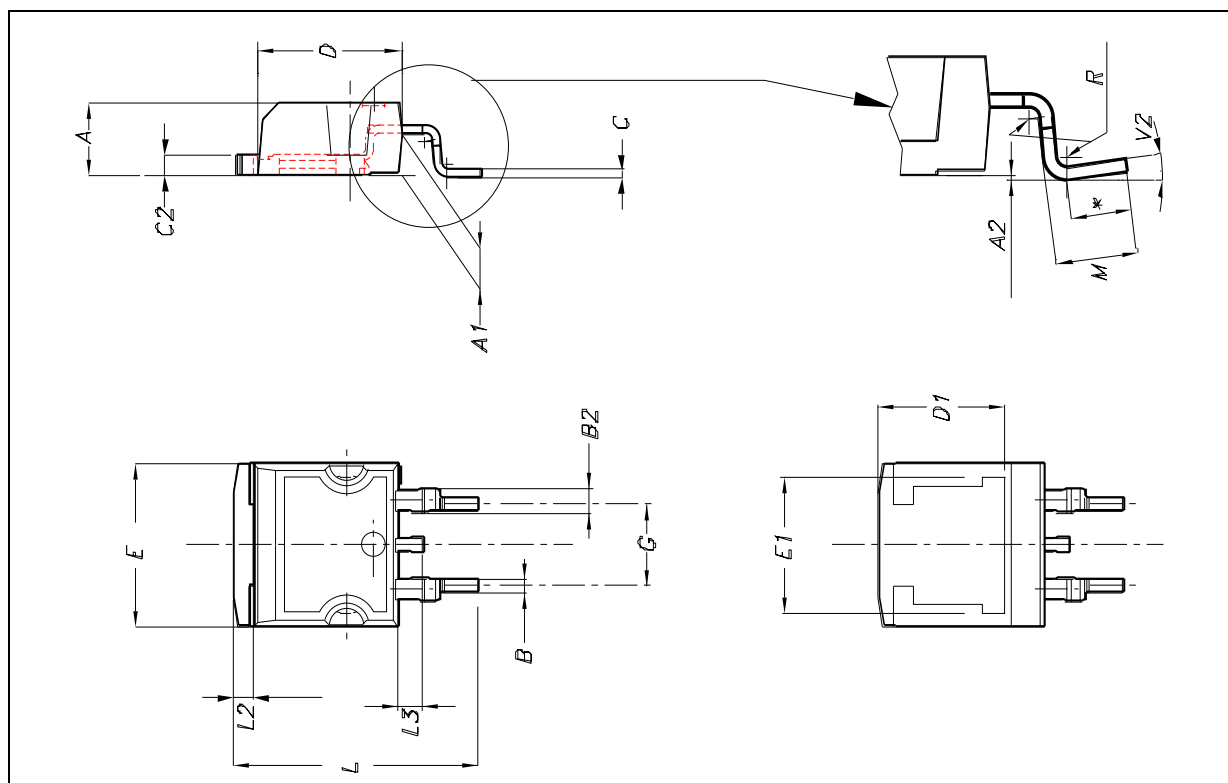

**Fig. 5: Test Circuit For Inductive Load Switching And Diode Recovery Times**



D<sup>2</sup>PAK MECHANICAL DATA

DIM.	mm.			inch.		
	MIN.	TYP.	MAX.	MIN.	TYP.	TYP.
A	4.4		4.6	0.173		0.181
A1	2.49		2.69	0.098		0.106
A2	0.03		0.23	0.001		0.009
B	0.7		0.93	0.028		0.037
B2	1.14		1.7	0.045		0.067
C	0.45		0.6	0.018		0.024
C2	1.21		1.36	0.048		0.054
D	8.95		9.35	0.352		0.368
D1		8			0.315	
E	10		10.4	0.394		0.409
E1	8.5				0.334	
G	4.88		5.28	0.192		0.208
L	15		15.85	0.591		0.624
L2	1.27		1.4	0.050		0.055
L3	1.4		1.75	0.055		0.069
M	2.4		3.2	0.094		0.126
R		0.4			0.016	
V2	0°		8°	0°		8°







Information furnished is believed to be accurate and reliable. However, STMicroelectronics assumes no responsibility for the consequences of use of such information nor for any infringement of patents or other rights of third parties which may result from its use. No license is granted by implication or otherwise under any patent or patent rights of STMicroelectronics. Specifications mentioned in this publication are subject to change without notice. This publication supersedes and replaces all information previously supplied. STMicroelectronics products are not authorized for use as critical components in life support devices or systems without express written approval of STMicroelectronics.

The ST logo is registered trademark of STMicroelectronics  
© 2002 STMicroelectronics - All Rights Reserved

All other names are the property of their respective owners.

STMicroelectronics GROUP OF COMPANIES  
Australia - Brazil - Canada - China - Finland - France - Germany - Hong Kong - India - Israel - Italy - Japan - Malaysia - Malta - Morocco -  
Singapore - Spain - Sweden - Switzerland - United Kingdom - United States.

<http://www.st.com>

